

# CR100-CRM

Mobile

QM77

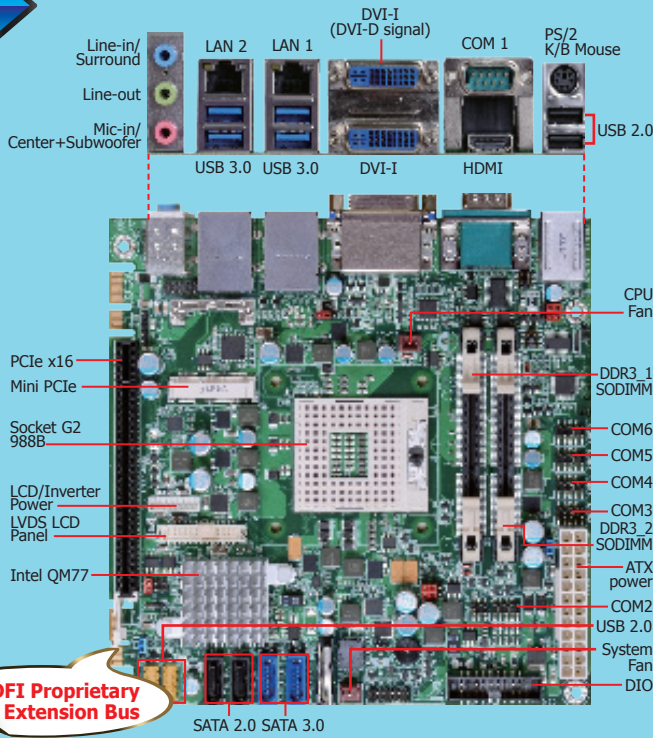

Two DFI Proprietary Extension Bus



## Mechanical Drawing

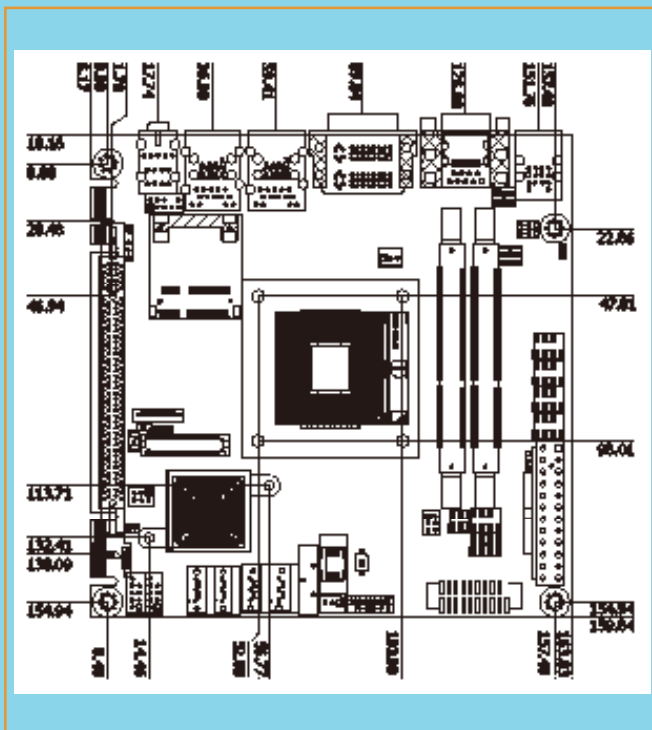

## Features

|                 |   |
|-----------------|---|
| MEMORY          | 2 DDR3/DDR3L SODIMM up to 16GB  |
| EXPANSION       | 1 PCIe x16<br>2 DFI Proprietary Extension Bus<br>1 Mini PCIe                  |
| DISPLAY OUTPUTS | 3 Independent Displays<br>1 HDMI, 1 LVDS<br>2 DVI-I (1 supports DVI-D signal) |
| LAN             | 2 LAN   |
| COM             | 6 COM   |
| USB             | 10 USB: 4 USB 3.0, 6 USB 2.0  |
| STORAGE         | 4 SATA: 2 SATA 3.0, 2 SATA 2.0  |
| DIO             | 8-bit DIO   |



DFI's Proprietary Technology

## 6 Riser Cards for DFI Proprietary Extension Bus

### H Series:

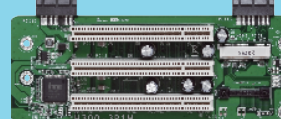

H300-3P1M

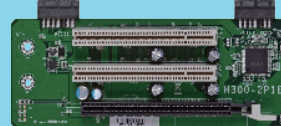

H300-2P1E



H300-2E

### T Series:



T300-3P1M

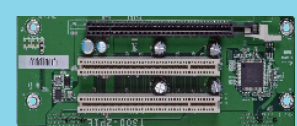

T300-2P1E

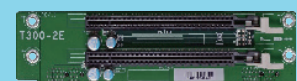

T300-2E

## Block Diagram

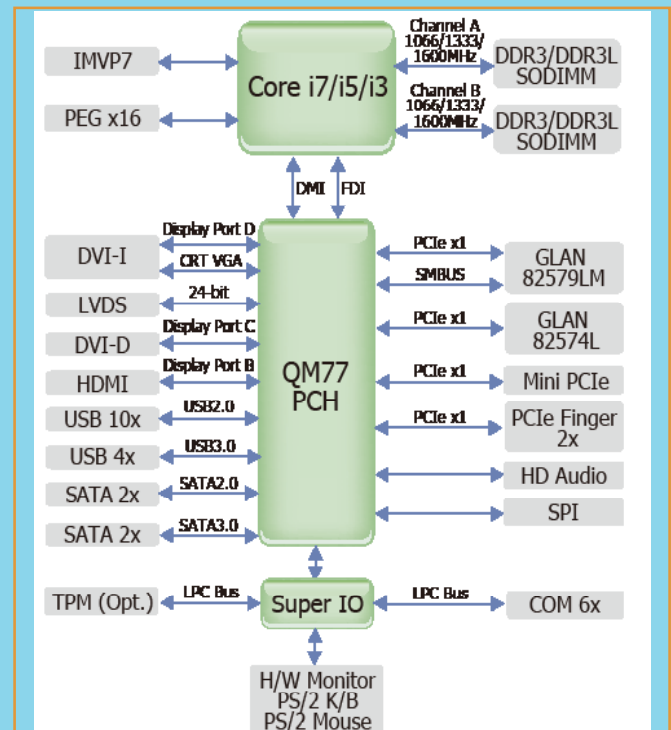

# CR100-CRM

## ► Specifications \* Optional and is not supported in standard model. Please contact your sales representative for more information.

### PROCESSOR

- Socket G2 988B for:
  - 3rd Generation Intel® Core™ processors (22nm process technology)
    - : Intel® Core™ i7-3610QE (6M Cache, up to 3.3 GHz); 45W
    - : Intel® Core™ i5-3610ME (3M Cache, up to 3.3 GHz); 35W
    - : Intel® Core™ i3-3120ME (3M Cache, 2.4 GHz); 35W
  - 2nd Generation Intel® Core™ processors (32nm process technology)
    - : Intel® Core™ i7-2710QE (6M Cache, up to 3.0 GHz); 45W
    - : Intel® Core™ i5-2510E (3M Cache, up to 3.1 GHz); 35W
    - : Intel® Core™ i3-2330E (3M Cache, 2.2 GHz); 35W
    - : Intel® Celeron® B810 (2M Cache, 1.6 GHz); 35W

### CHIPSET

- Intel® QM77 Express chipset

### SYSTEM MEMORY

- Two 204-pin SODIMM sockets
- Supports DDR3 SODIMM

| 3rd Generation Processors | 2nd Generation Processors         |
|---------------------------|-----------------------------------|
| DDR3 1066/1333/1600MHz    | DDR3 1066/1333MHz (i5/i3/Celeron) |
|                           | DDR3 1600MHz (i7)                 |

- Supports DDR3L SODIMM
  - 1066/1333MHz when operating at 1.35V
  - 1066/1333/1600MHz when operating at 1.5V
- Supports dual channel memory interface
- Supports up to 16GB system memory
- DRAM device technologies: 1Gb, 2Gb and 4Gb DDR3 DRAM technologies are supported for x8 and x16 devices, unbuffered, non-ECC

### EXPANSION SLOTS

- 1 PCIe x16 slot
  - Supports Gen 3.0 (3rd generation processors)
  - Supports Gen 2.0 (2nd generation processors)
  - Configurations (supported only via a riser card):
    - : One x8 (GFX) and two x4 (I/O)
    - : Two x8 (GFX, I/O)
    - : One x16 (GFX, I/O)
- 2 DFI Proprietary Extension Bus for PCIe/PCI expansion
- 1 Mini PCIe slot (PCIe and USB signals)
  - Supports half size Mini PCIe card

### ONBOARD GRAPHICS FEATURES

- Intel® HD Graphics 4000
- Display ports: HDMI, 2 DVI-I (1 supports DVI-D signal only), and LVDS
- HDMI, DVI: resolution up to 1920x1200 @ 60Hz
- VGA: resolution up to 2048x1536 @ 75Hz, 32-bit
- LVDS: Single Channel - 18/24-bit; Dual Channel - 36/48-bit, resolution up to 1920x1200 @ 60 Hz
- Intel® Clear Video Technology
- DirectX Video Acceleration (DXVA) for accelerating video processing
  - Full AVC/VC1/MPEG2 HW Decode
- Supports DirectX 11/10.1/10/9 and OpenGL 3.0

### ONBOARD AUDIO FEATURES

- Realtek ALC886 5.1-channel High Definition Audio
- Audio outputs: Mic-in/Center+Subwoofer, line-in/surround and line-out
- S/PDIF audio interface

### ONBOARD LAN FEATURES

- Intel® WG82579LM with iAMT8.0 Gigabit Ethernet Phy
- Intel® WG82574L PCI Express Gigabit Ethernet controller
- Integrated 10/100/1000 transceiver
- Fully compliant with IEEE 802.3, IEEE 802.3u, IEEE 802.3ab

### SERIAL ATA (SATA) INTERFACE

- 4 Serial ATA ports
  - 2 SATA 3.0 ports with data transfer rate up to 6Gb/s
  - 2 SATA 2.0 ports with data transfer rate up to 3Gb/s
- Integrated Advanced Host Controller Interface (AHCI) controller
- Supports RAID 0/1/5/10

### INTEL ACTIVE MANAGEMENT TECHNOLOGY (AMT)

- Supports iAMT8.0
- Out-of-band system access
- Remote troubleshooting and recovery
- Hardware-based agent presence checking
- Proactive alerting
- Remote hardware and software asset tracking

## ► Packing List

- 1 CR100-CRM motherboard
- 1 USB port cable (with bracket)
- 2 Serial ATA data cables
- 2 COM port cables (with bracket)
- 1 I/O shield
- 1 DVD
- 1 QR (Quick Reference)

### TRUSTED PLATFORM MODULE (TPM)\*

- Provides a Trusted PC for secure transactions
- Provides software license protection, enforcement and password protection

### USB INTERFACE

- XHCI Host Controller supports up to 4 super speed USB 3.0 ports

### REAR PANEL I/O PORTS

- 1 mini-DIN-6 port for PS/2 mouse/keyboard
- 4 USB 3.0/2.0/1.1 ports
- 2 USB 2.0/1.1 ports
- 1 DB-9 serial port
  - Supports RS232/422/485 (RS232 and/or Power)
- 1 HDMI port
- 2 DVI-I ports (1 supports DVI-D signal)
- 2 RJ45 LAN ports
- Line-in/surround, Line out, and Mic-in/Center+Subwoofer jacks

### I/O CONNECTORS

- 2 connectors for 4 external USB 2.0/1.1 ports
- 5 connectors for 5 external serial ports
  - 1 RS232/422/485 (RS232 and/or Power); 4 RS232
- 1 LVDS LCD panel connector
- 1 LCD/inverter power connector
- 1 8-bit Digital I/O connector
- 1 front audio connector for line-out and mic-in jacks
- 1 S/PDIF connector
- 4 Serial ATA ports (2 SATA 3.0; 2 SATA 2.0)
- 1 24-pin ATX power connector
- 1 chassis intrusion connector
- 1 front panel connector
- 2 fan connectors

### BIOS

- AMI BIOS
  - 64Mbit SPI BIOS

### ENERGY EFFICIENT DESIGN

- Supports ErP Lot6 power saving\*
- ACPI v3.0 specification
- System Power Management
- Wake-On-Events include:
  - Wake-On-PS/2 KB/Mouse
  - Wake-On-USB KB/Mouse
  - Wake-On-LAN
  - RTC timer to power-on the system
- AC power failure recovery

### DAMAGE FREE INTELLIGENCE

- Monitors CPU/system temperature and overheat alarm
- Monitors VCore/1.05V/DDR/3.3V/5V/12V voltages and failure alarm
- Monitors CPU/system fan speed and failure alarm
- Read back capability that displays temperature, voltage and fan speed
- Watchdog timer function
  - Watchdog timeout programmable via software from 1 to 255 seconds

### POWER CONSUMPTION

- 42.86 W with i7-3610QE at 2.3GHz and 2x 1GB DDR3 SODIMM

### OS SUPPORT

- Windows XP Professional x86 & SP3 (32-bit)
- Windows XP Professional x64 & SP2 (64-bit)
- Windows 7 Ultimate x86 & SP1 (32-bit)
- Windows 7 Ultimate x64 & SP1 (64-bit)
- Windows 8 Enterprise x86 (32-bit)
- Windows 8 Enterprise x64 (64-bit)

### TEMPERATURE

- Operating: 0°C to 60°C
- Storage: -20°C to 85°C

### HUMIDITY

- 10% to 90%

### DIMENSIONS

- Mini-ITX form factor
- 170mm (6.7") x 170mm (6.7")

### CERTIFICATION

## ► Optional Items

- USB port cable
- Serial ATA data cable
- Serial ATA power cable
- COM port cable
- I/O shield